

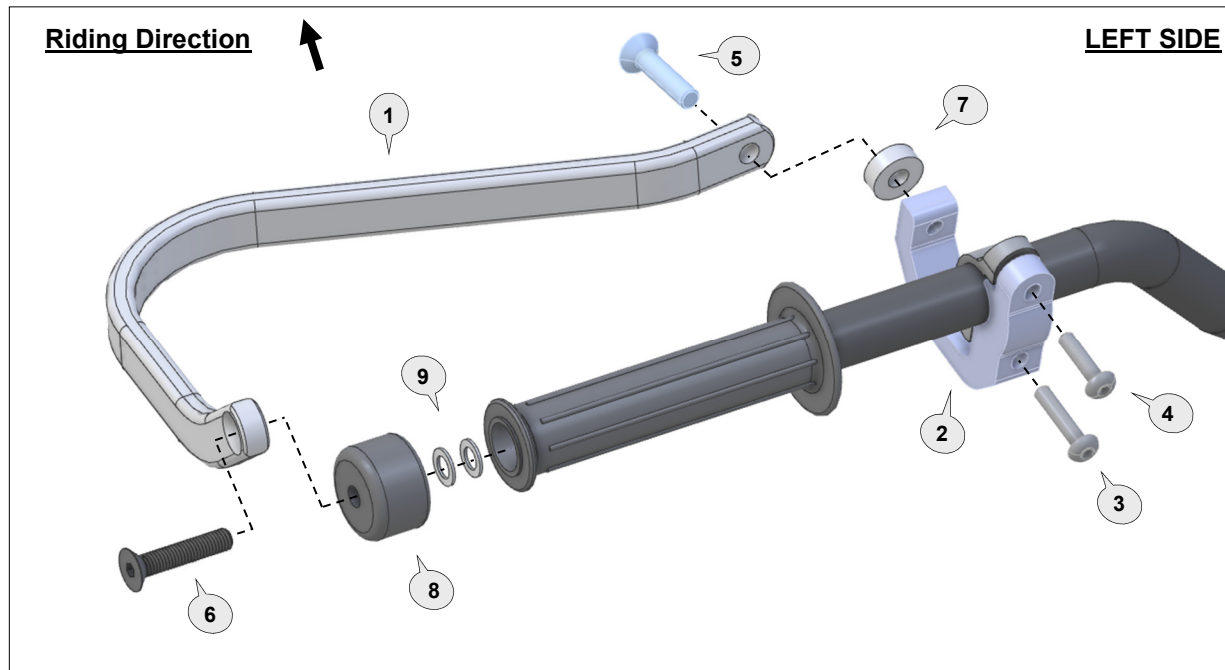

www.barkbusters.net

FITTING INSTRUCTIONS for...

- Royal Enfield Himalayan (2023-on)



Preparation

Remove original bar end weights.

Fitting Procedure shown for the Left side

(repeat for Right side with applicable parts.)

- Loosely assemble clamp (2) to handlebar as per diagram.
- Pre-assemble parts (6), (1), (8) and (9) and then present the assembly to the end of the handlebar, making sure the clamp (2) aligns with the end of the backbone (1).
- Loosely tight screw (6). While making sure the assembly is in the right position,
- Insert screw (5) through the backbone (1) and the spacer (7) into the clamp (2)

Note: The preferred backbone position is horizontal when viewed from the side.

Tighten all bolts in the following order (6), (5), then (3 and 4) evenly. Use recommended torque specifications over page.

Bar Side View

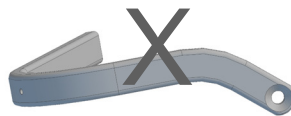
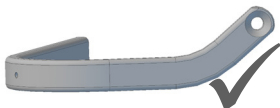

Personalise Your Protection

Guard options sold separately

JET	JET-003
VPS	VPS-003
Storm	STM-003
CARBON	BCF-003



INS-BHG-111-00-NP



Email: info@barkbusters.net
[@BARKBUSTERSHANDGUARDS](https://www.instagram.com/BARKBUSTERSHANDGUARDS)

1 Aluminium Bar



PN: BAR-V058
Pcs. 2 (L & R)

2 Clamp Frame & Saddle (left)



PN: CFS-ADV-23
Pcs. 2 (L & R)

3 Button Head Bolt 30mm



PN: M6x30BHCSZP
Pcs. 2

4 Button Head Bolt 20mm

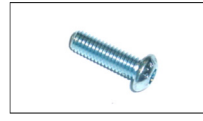

PN: M6x20BHCSZP
Pcs. 2

5 Flat Head Bolt 30mm



PN: M8x30FHCSZP
Pcs. 2

6 Flat Head Screw 45mm



PN: M8x45FHCSZP
Pcs. 2

7 Spacer (7mm)



PN: SP07-20-8
Pcs. 2

8 Bar End Weight



PN: BEW35
Pcs. 2

9 M8 Flat Washer



PN: M8FW-SS
Pcs. 4

Recommended Torque Settings	
M6	10 Nm (7.4 lbf ft)
M8	28 Nm (20.7 lbf ft)

CAUTION:

Installation of the handguard is safety-relevant work and can be complicated. We recommend the installation be performed by a motorcycle service technician. Rideworx accepts no liability for damages caused by improper mounting. All screws, bolts and nuts, including all replacement hardware provided by Rideworx, should be tightened to the torque specified in the table. After the first 50km of riding check all screws, bolts and nuts are tightened to the correct torque. We recommend a medium strength liquid thread lock product on all fasteners.

WARNING:

Check operation of all handlebar controls, specifically the throttle, front brake, kill switch and clutch to ensure they are operating correctly and are in accordance with the OEM specifications. Do not ride the motorcycle if any controls are not operating correctly or if rear view mirror vision is obscured. Check periodically that all bolts are tight.



Phone: +61 (0)2 4271 8244
Email: info@barkbusters.net
Web: www.barkbusters.net



Disclaimer:

A failure to follow these fitting instructions could cause serious injury, death or property damage. These handguards are intended solely for use with motorcycles/ATV/snowmobiles/scooters that have not been modified. They are not designed to prevent injury or death while riding or in an accident or crash. The user must ensure that all controls are free of the handguards every time that they ride. By installing and/or using this product you acknowledge that you accept these terms and have followed the fitting instructions.