



FITTING INSTRUCTIONS for...

DUCATI Multistrada V4 ('21 on)
 DUCATI Multistrada V4S ('21 on)
 DUCATI Multistrada V4S SPORT ('21 on)
 CFMOTO 800MT Sport ('21 on)
 CFMOTO 800MT Touring ('21 on)
 CFMOTO 800MT Explore ('23 on)
 CFMOTO 800MT-X (25 on)
 CFMOTO 450MT ('24 on)

Preparation

Remove the original handguards and original bar end weights.

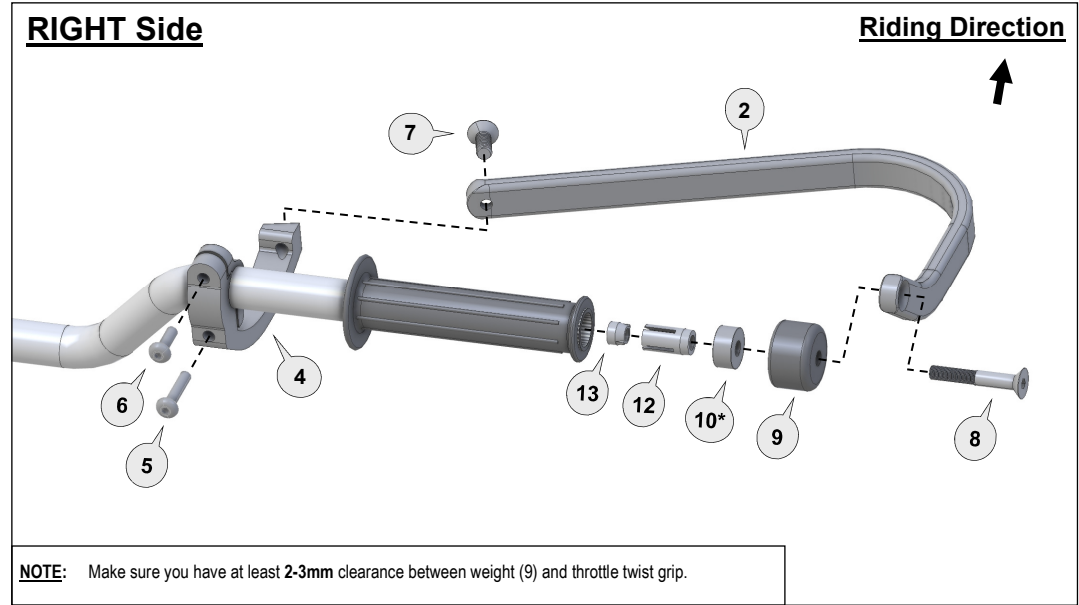
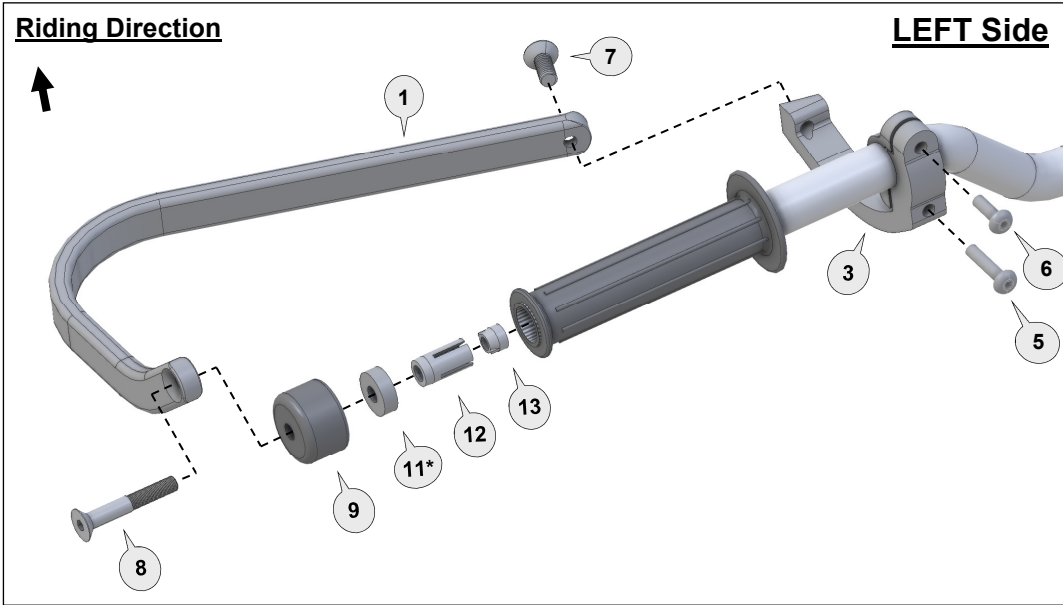

NOTE: Make sure you have at least 2-3mm clearance between weight (9) and throttle twist grip.

IMPORTANT FITTING TIPS FOR DUCATI LEFT SIDE ONLY:

The clutch lever housing may need to be moved to the left by 2 to 3 mm. The inner end of the clutch lever **MUST NOT** come in contact with the mounting bracket (3) when the clutch is pulled in.



(Appropriate setup shown of the clutch lever housing when repositioned)











Pull clutch in all the way and **ENSURE** there is at least 2-3mm clearance between the mounting bracket and inner end of clutch lever



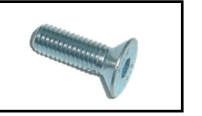

Fitting Procedure:

(Note: * For the CFMOTO 800MTs spacer (11) must be installed on the right side and spacer (10) on the left side)

- Loosely assemble clamp bracket (3 or 4) to the handlebar with applicable parts.
- Loosely attach the aluminium backbone (1 or 2) with applicable parts to the handlebar end and also to the mounting clamp bracket.
Note: The preferred backbone position is horizontal when viewed from the side.
- Tighten all bolts in the following order (8), then (7), then (5 and 6).
- Repeat procedure on opposite side.
- Use recommended torque specifications over page.

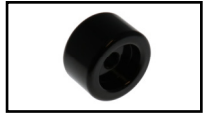
IMPORTANT: Once installed correctly, the mounting clamps should **NOT** hit the tank at full lock, as well as the backbone should **NOT** come in contact with the windshield in full turn.

<p>1 Aluminium Bar</p>  <p>PN: BAR-V-036 Pcs. 1 Left</p>	<p>2 Aluminium Bar</p>  <p>PN: BAR-V-036 Pcs. 1 Right</p>	<p>3 Clamp Frame & Saddle LEFT</p>  <p>PN: CFS20-L Pcs. 1</p>	<p>4 Clamp Frame & Saddle RIGHT</p>  <p>PN: CFS20-R Pcs. 1</p>	<p>5 Button Head Bolt 30mm</p>  <p>PN: M6X30BHCSZP Pcs. 2</p>	<p>6 Button Head Bolt 20mm</p>  <p>PN: M6X20BHCSZP Pcs. 2</p>	<p>7 Flat Head Bolt 25mm</p>  <p>PN: M8X25FHCSZP Pcs. 2</p>	<p>8 Flat Head Bolt 65mm</p>  <p>PN: M8X65FHCSZP Pcs. 2</p>
--	---	---	---	---	---	---	---

<p>9 Bar End Weight</p>  <p>PN: BEW35 Pcs. 2</p>	<p>10 Spacer (10mm) RIGHT</p>  <p>PN: BSSRT10 Pcs. 1</p>	<p>11 Spacer (7mm) LEFT</p>  <p>PN: SP07-20-08 Pcs. 1</p>	<p>12 Bar End Expander</p>  <p>PN: BBE14A Pcs. 2</p>	<p>13 Nut 12mm - Two wings</p>  <p>PN: NUT12 Pcs. 2</p>
--	--	---	---	---

Personalise Your Protection
Guard options sold separately

JET JET-003
VPS VPS-003
Storm STM-003
CARBON BCF-003

Recommended Torque Settings	
M6	10 Nm (7.4 lbf ft)
M8	28 Nm (20.7 lbf ft)

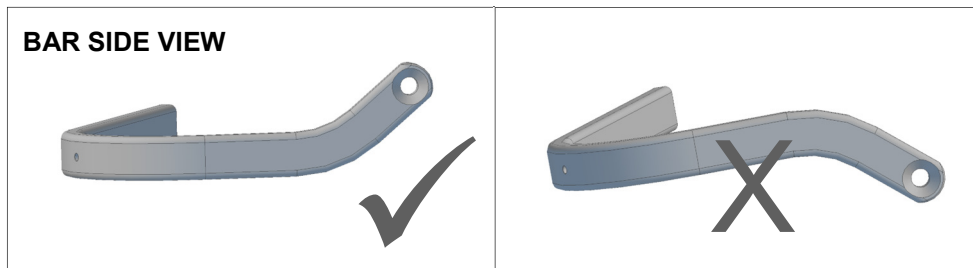

CAUTION:

Installation of the handguard is safety-relevant work and can be complicated. We recommend the installation be performed by a motorcycle service technician. Rideworx accepts no liability for damages caused by improper mounting. All screws, bolts and nuts, including all replacement hardware provided by Rideworx, should be tightened to the torque specified in the table. After the first 50km of riding check all screws, bolts and nuts are tightened to the correct torque. We recommend a medium strength liquid thread lock product on all fasteners.

WARNING:

Check operation of all handlebar controls, specifically the throttle, front brake, kill switch and clutch to ensure they are operating correctly and are in accordance with the OEM specifications. Do not ride the motorcycle if any controls are not operating correctly or if rear view mirror vision is obscured. Check periodically that all bolts are tight.

Disclaimer:

A failure to follow these fitting instructions could cause serious injury, death or property damage. These handguards are intended solely for use with motorcycles/ATV/snowmobiles/scooters that have not been modified. They are not designed to prevent injury or death while riding or in an accident or crash. The user must ensure that all controls are free of the handguards every time that they ride. By installing and/or using this product you acknowledge that you accept these terms and have followed the fitting instructions.



Email: info@barkbusters.net
Web: www.barkbusters.net

